

4

3

4

2

三 角 法 (THIRD ANGLE PROJECTION)

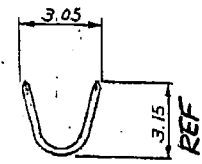
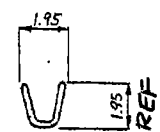
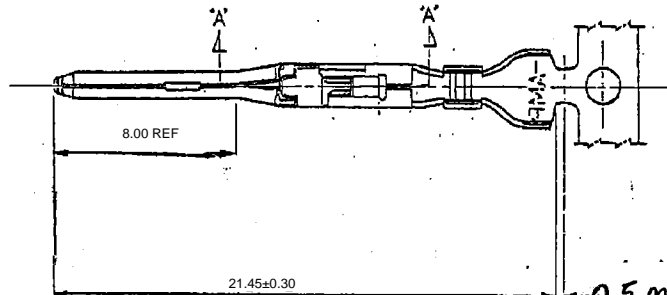
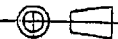

断面 C-C (SECT.)

断面 D-D (SECT.)

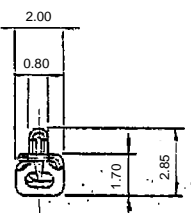

断面 B-B (SECT.)

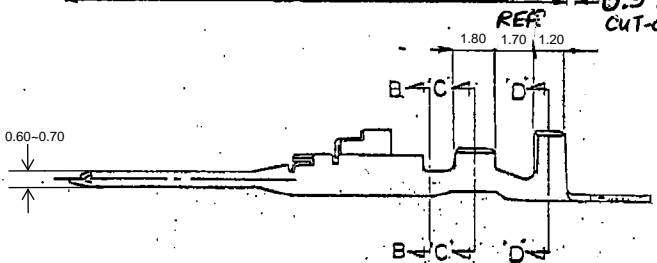

断面 A-A (SECT.)

注: 1. 通用規格
製品規格 108-5302
取付通用規格 114-5142
取扱説明書 IS-503J

NOTES: 1. APPLICABLE SPEC.
PRODUCT SPEC. 108-5302
APPLICATION SPEC. 114-5142
2. INSTRUCTION SHEET IS-503J

	NYE製: 502H-20-UV (NYE: 502H-20-UV 107)カド才化処理 (APPLIED LUBRICANT OIL)	錫めっき黄銅 (PRE-TINNED BRASS)	175149-3
175153-2		錫めっき黄銅 (PRE-TINNED BRASS)	175149-2
175153-1		錫めっき黄銅合金 (PRE-TINNED COPPER ALLOY)	175149-1
バッチ端子型番 (L.P. P/N)	仕上 (FINISH)	材 料 (MATERIAL)	型番 (P/N)

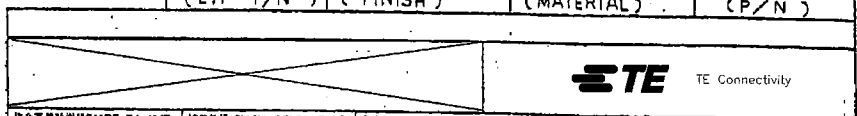

C4	REVISED PER ECR-23-176215	M.G.	D.Z.	012-035mm(awg#26-22)	1.2-2mm	仕様 (NAME) (TAB CONTACT AMP. UNIVERSAL POWER CONN.)	77-コネクタ, アンテナバー-サルバワ-コネクタ
C3	REVISED PER ECR-20-100273	M.G.	D.Z.	材質 (MATERIAL) 表参照	仕様 (SPEC.) 表参照	一仕立	SIZE LOC 番号 (NO.)
C2	REV ECR M-006821	OK	TM	DR. 表参照	DE 表参照	2PLC:±0.20	B J C-175149
C1	REVISED PER ECO-11-005030	RK	HMR	CHK 表参照	APP 表参照	ANGLE:±3°	尺取 (SCALE) 5-1
LTR	改訂 (REVISION RECORD)	DR.	CHK.	DATE	DATE		REV. C4 SHEET

単位: mm DIMENSIONS IN MM. DO NOT SCALE PRINT

PRINT DIST

4

3

2

三角法 (THIRD ANGLE PROJECTION)

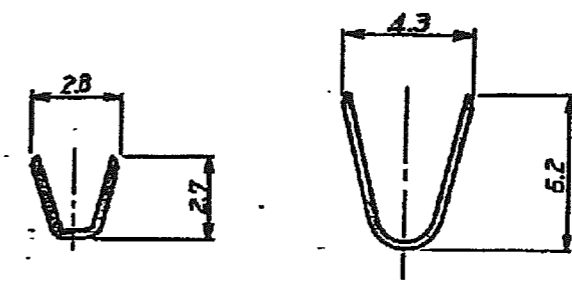
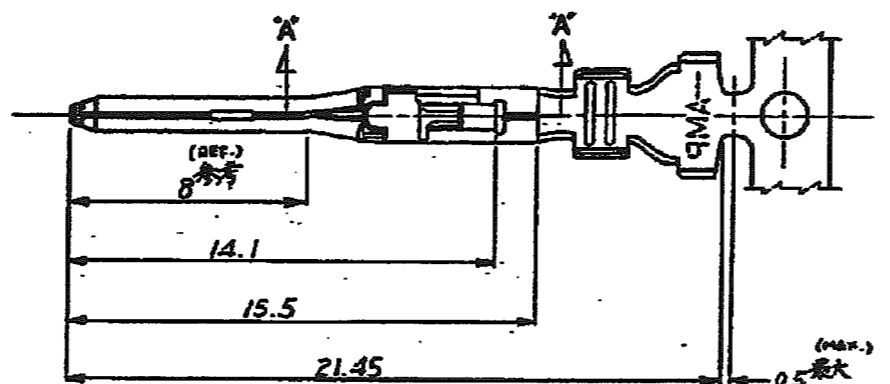
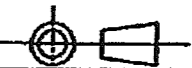

断面 C-C (SECT.)

断面 D-D (SECT.)

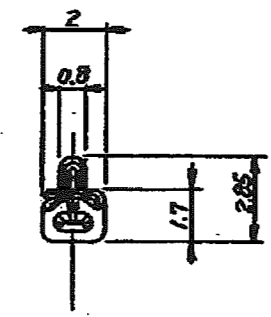

断面 B-B (SECT.)

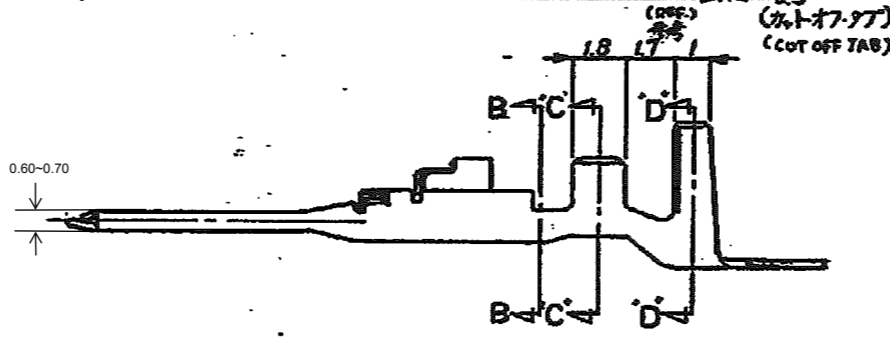

断面 A-A (SECT.)

(MAX.)
0.5 最大
(カットオフタブ)
(CUT OFF TAB)

- 注: 1. 適用規格
 製品規格 108-5302
 取付適用規格 114-5142
 取扱説明書 IS-503J

NOTES: 1 APPLICABLE SPEC
 PRODUCT SPEC: 108-5302
 APPLICATION SPEC: 114-5142
 2. INSTRUCTION SHEET, IS-503J

単位: 0.1 DIMENSIONS IN MM. DO NOT SCALE PRINT

175154-2	---	錫めっき黄銅 (PRE TINNED BRASS)	175150-2
175154-1	---	錫めっき銅合金 (PRE TINNED COPPER ALLOY)	175150-1
パラレル端子型番 (L.P. P/N)	仕上 (FINISH)	材料 (MATERIAL)	型番 (P/N)

STE TE Connectivity

品番 (PART NUMBER) 175150-2 品名 (TAB CONTACT AMP UNIVERSAL POWER CONN.)

規格 (SPECIFICATION) 1.7~3.3mm 仕様 (SPECIFICATION) 77-コネクタ, アンバー-ユニバーサルパワー-コネクタ

REV. 01	REV. 02	REV. 03	REV. 04
DATE	DATE	DATE	DATE

SIZE LOC # (NO.)
B J C-175150

REV. (SCALE) 5-1 REV. C2 SHEET

C2	REVISED PER ECR-20-100273	M.G	D.Z	10AUG20
C1	REVISED PER ECO-11-005030	RK	HMR	22MAY11
LTR	SEE PREVISION RECORDS	DR	CHK	DATE

(CUSTOMER DRAWING) 参考図面